

FOAM MAKER

MODEL - FMA & FMA-S



TECHNICAL DATA

MODEL	FMA-50, FMA-65 - Carbon Steel Construction FMA-S 50, FMA-S 65 - Stainless Steel Construction
INLET SIZE	50 NB, 65 NB
WORKING PRESSURE	Minimum 2.8 Kg/sq. cm. (40 PSI) Maximum 7 Kg/sq. cm. (100 PSI)
FLANGE CONNECTION	ANSI B16.5 class 150#SORF
FINISH	Red RAL 3001 standard supply Other shade optional
WEIGHT (Approx.)	50 NB - 9.9 Kg 65 NB - 14.0 Kg
APPROVAL	UL Listed & FM Approved Refer Table-I
ORDERING INFORMATION	Specify: a) Model and inlet size b) Inlet pressure c) Flow Solution flow required. d) Inlet Outlet flange e) Type of Foam Concentrate used

APPLICATION

Foam Maker is used for one of the most common applications of protecting tank seal in vertical liquid storage tank with internal floating roof with low expansion foam system. The application of aspirated foam is on the basis of the risk comprising the area in the annular ring between the rim of the floating roof and the tank shell. The Foam system design guidelines generally used are in accordance with NFPA11 standard. The Foam Makers are defined by NFPA 11 as Type II discharge outlets for delivering the low expansion aspirated foam to the seal. The Foam Makers are widely used with the Inline Foam Inductor, Balance Pressure Foam Proportioning system, Bladder Tank system and Foam tenders.

SPECIFICATION

Foam Maker is an air aspirating foam generator connected to the foam pourer to deliver the aspirated foam gently into the tank seal area. Foam maker covers wide range of foam solution rates from 75 to 557 litres per minute at 2.8 to 7 kg/sq.cm. inlet pressure. The orifice is field replaceable in the event of change in design parameters. The foam is produced by introducing air into the foam solution stream.



The inlet of foam maker is designed to create venturi jet which draws air into the foam solution stream. The air is drawn into the foam solution through holes located on the foam maker covered with stainless steel screen to exclude nesting birds and insects. The aerated foam is directed into the pourer for the gentle application of the expanded foam. The pourers are available in different models.*

* Refer to UL/FM directory for specific foam concentrate along with working pressure and flow details.

INSTALLATION, TESTING AND MAINTENANCE

Carefully unpack Foam Maker. While unpacking and installation, it is to be handled with care and shocks to be avoided. Check visually for any damages. While installing, ensure that the Foam Maker is not under stress due to any misalignments in installation or variations of system piping. Ensure that the strainer assembly is clear from any blockages or damages. If strainer assembly is either blocked or damaged will adversely affect the performance of the equipment.

Qualified and trained person must commission the system. After few initial successful tests, an authorized person must be trained to perform inspection and testing of the system. It is recommended to carry out physical inspection of the system regularly. The system must be fully tested at least once in a year or in accordance to standards of the organization having local jurisdiction.

Do not turn off the system or any valve to make repair or test the system, without placing a roving Fire Patrol in the area covered by the system. The Patrol should continue until the system is put back in service. Also inform the local security guard and control alarm station, so as to avoid false alarm.

Each system is to be flushed properly. To test the Foam Maker without discharging the foam into the tank seal area, the foam maker is to be rotated 180° away from the wind shield. The air screen is to be inspected periodically for obstruction of air inlet holes. If any obstruction is noticed, remove the same and flush if necessary. The foam maker outlet and pourer, if exposed to atmospheric condition, should be periodically inspected for nest and other obstructions. Any obstruction if noticed must be removed and flushed to clear the discharge path.

NOTE:

1. A PROVISION IS TO BE MADE FOR PRESSURE GAUGE MOUNTING AT INLET OF FOAM MAKER, WHICH MAY BE PLUGGED AFTER SUCCESSFUL COMMISSIONING OF THE SYSTEM. THIS WILL HELP TO ANALYSE THE SYSTEM WHILE COMMISSIONING.
2. THE OWNER IS RESPONSIBLE FOR THE TESTING, INSPECTION AND MAINTENANCE OF THE FOAM MAKER AND THE SYSTEM.
3. FM APPROVAL AND UL LISTING OF EQUIPMENT ARE VALID ONLY WHEN USED WITH HD FOAM CONCENTRATE IN A MANNER AS PER FM/UL APPROVAL DATA.
4. FM APPROVAL IS VALID ONLY WHEN TOTAL SYSTEM IS HAVING FM APPROVED PRODUCTS.
5. REFER TO THE INDIVIDUAL FOAM UL LISTING & FM APPROVAL FOR OPERATING AND LIMITATION WITH EACH FOAM CONCENTRATE AND FOAM MAKER.

Selection of HD Foam Maker:

To select the size of the Foam Maker use the following formula:

$$Q = K \sqrt{P}$$

Where,

Q = Total solution flow in litres per minute.

K = Constant for Foam Chamber

P = Inlet pressure in kg/sq.cm.

Example:

To find K factor: Q = 150 LPM

$$P = 3.5 \text{ Kg/sq.cm.}$$

$$K = 150 \div \sqrt{3.5} = 80.17$$

The K-Factor 80.17 falls within the range of the Foam Maker having 50NB size. Hence 50NB size Foam Maker to be selected.

The Foam Maker can also be selected by using graph.

TABLE I - Selection of 50 NB HD Foam Maker

FOAM CONCENTRATE	AFFF 3%	AFFF 3%	AR-AFFF 3X3%
* APPROVALS	UL LISTED	FM APPROVED	
WORKING PRESSURE	2.8 Kg/cm ² to 7 Kg/cm ²	2.8 Kg/cm ² to 7 Kg/cm ²	5.2 Kg/cm ² to 7 Kg/cm ²
K-FACTOR	44.8 to 126.6	56.8 to 132.3	99.5 to 138.0

TABLE II - Selection of 65 NB HD Foam Maker

FOAM CONCENTRATE	AFFF 3%	AFFF 3%	AR-AFFF 3X3%
* APPROVALS	UL LISTED	FM APPROVED	
WORKING PRESSURE	2.8 Kg/cm ² to 7 Kg/cm ²	4.9 Kg/cm ² to 7 Kg/cm ²	3.5 Kg/cm ² to 7 Kg/cm ²
K-FACTOR	89.6 to 207.8	158 to 210.5	82.9 to 211.7

* Refer to UL/FM directory for specific foam concentrate, working pressure and flow.

FOAM MAKER

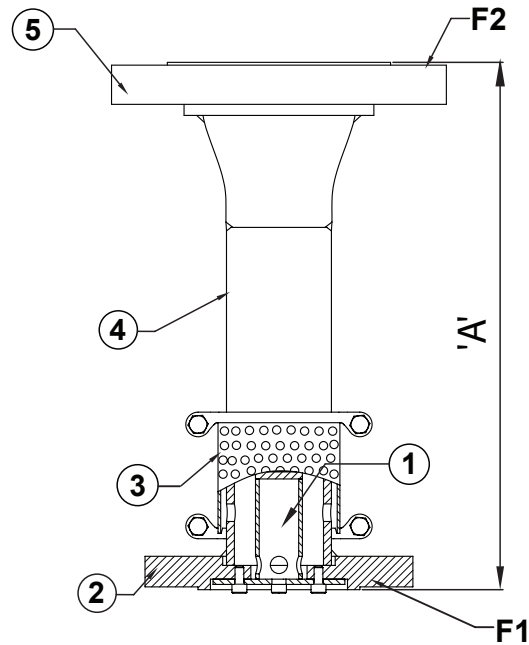

DIMENSIONS OF FOAM MAKER in millimeter (Approximate)

MODEL	FOAM MAKER SIZE	INLET (F1)	OUTLET (F2)	A
FMA 50 & FMA-S 50	50NB	50NB	80NB	300
FMA 65 & FMA-S 65	65NB	65NB	100NB	400

PART LIST

ITEM NO.	DESCRIPTION	MATERIAL SPECIFICATION	
		FMA	FMA-S
1	ORIFICE ASSEMBLY	STAINLESS STEEL	STAINLESS STEEL
2	INLET FLANGE	STEEL	STAINLESS STEEL
3	STRAINER ASSEMBLY	STAINLESS STEEL	STAINLESS STEEL
4	FOAM MAKING CHAMBER	STEEL PIPE	SS PIPE
5	OUTLET FLANGE	STEEL	STAINLESS STEEL

NOTE :

Strainer Assembly consists of SS perforated sheet, SS Strainer holder & Galvanised Nut/Bolt.

TYPICAL INSTALLATION OF FOAM MAKER WITH POURER

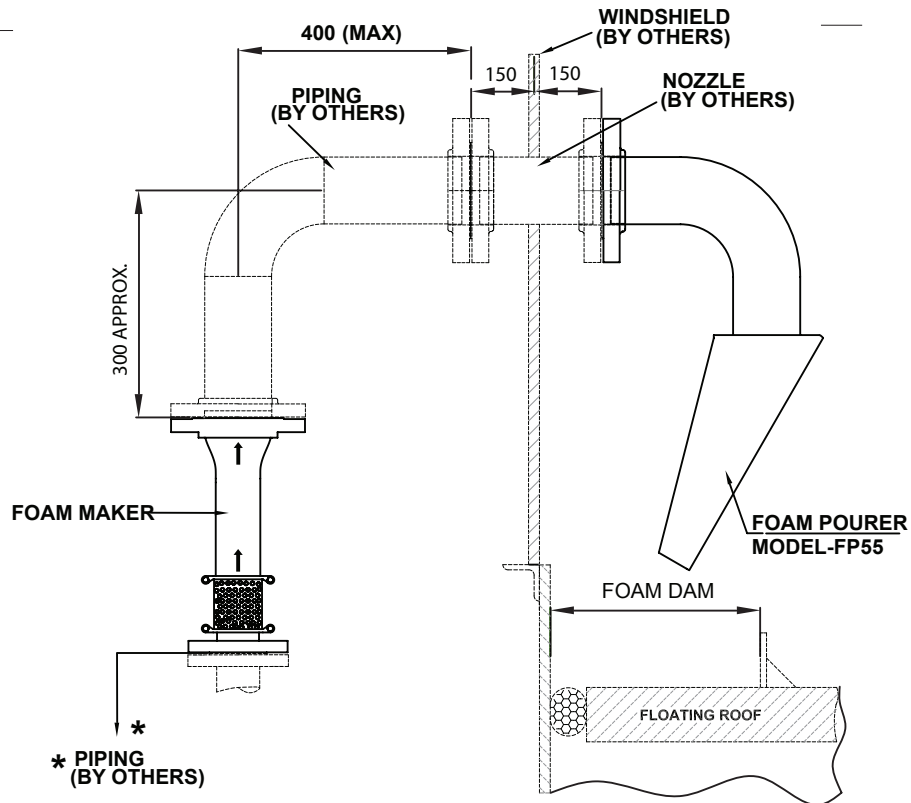

NOTE:

1. Above dimensions (in mm) are for general guidelines only. The system designer can adopt the dimensions as per NFPA/OISD or as per the governing rules & ordinance having local jurisdiction.
2. See the UL Listing and FM Approval details for foam details or contact HD sales.
3. Foam Pourer Model - FP55 is standard supply in carbon steel material and optional in stainless steel.

PRESSURE VS FLOW PERFORMANCE CHARACTERISTIC

UL LISTED WITH FOAM CONCENTRATE AFFF 3%

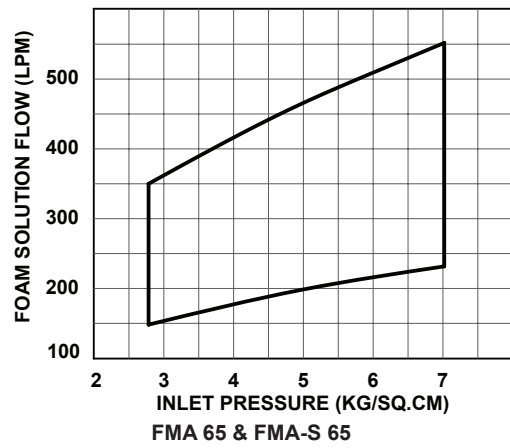
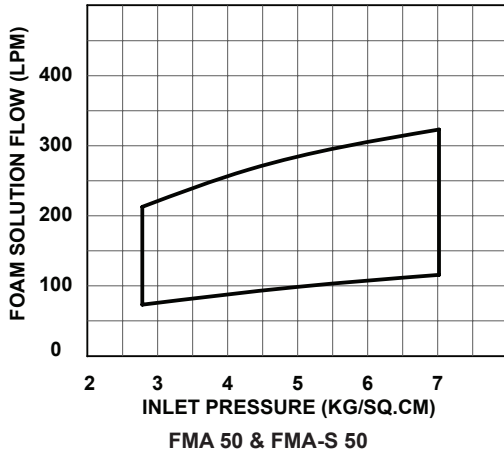

PRESSURE VS FLOW PERFORMANCE CHARACTERISTIC

FM APPROVED WITH FOAM CONCENTRATE AFFF 3%

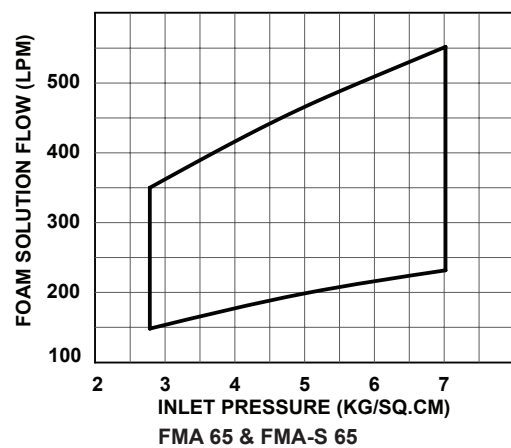
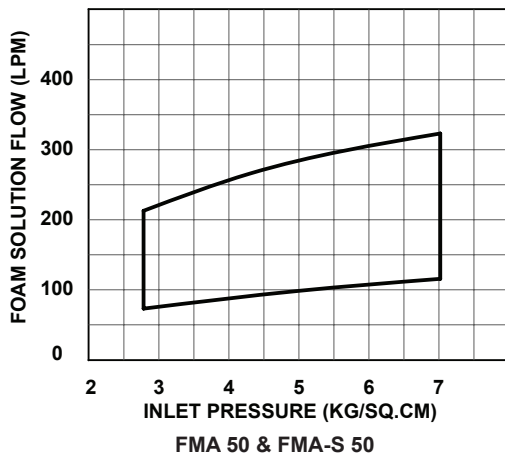

PRESSURE VS FLOW PERFORMANCE CHARACTERISTIC

FM APPROVED WITH FOAM CONCENTRATE AR-AFFF 3X3%

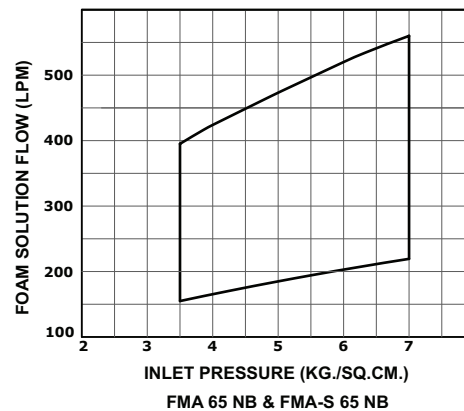
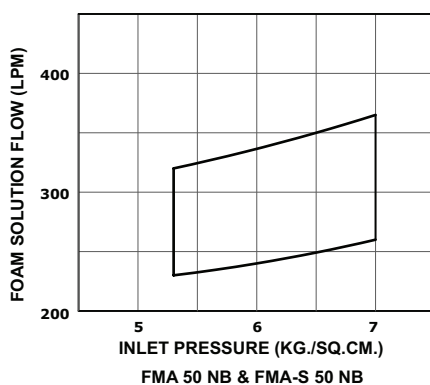

LIMITED WARRANTY

HD FIRE PROTECT PVT. LTD. hereby referred to as HD FIRE warrants to the original purchaser of the fire protection products manufactured by HD FIRE and to any other person to whom such equipment is transferred, that such products will be free from defect in material and workmanship under normal use and care, for two (2) years from the date of shipment by HD FIRE. Products or Components supplied or used by HD FIRE, but manufactured by others, are warranted only to the extent of the manufacturer's warranty. No warranty is given for product or components which have been subject to misuse, improper installation, corrosion, unauthorized repair, alteration or un-maintained. HD FIRE shall not be responsible for system design errors or improper installation or inaccurate or incomplete information supplied by buyer or buyer's representatives. HD FIRE will repair or replace defective material free of charge, which is returned to our factory, transportation charge prepaid, provided after our inspection the material is found to have been defective at the time of initial shipment from our works. HD FIRE shall not be liable for any incidental or consequential loss, damage or expense arising directly or indirectly from the use of the product including damages for injury to person, damages to property and penalties resulting from any products and components manufactured by HD FIRE. HD FIRE shall not be liable for any damages or labour charges or expense in making repair or adjustment to the product. HD FIRE shall not be liable for any damages or charges sustained in the adaptation or use of its engineering data & services. In no event shall HD Fire's product liability exceed an amount equal to the sale price. The foregoing warranty is exclusive and in lieu of all other warranties and representation whether expressed, implied, oral or written, including but not limited to, any implied warranties or merchantability or fitness for a particular purpose. All such other warranties and representations are hereby cancelled.

NOTICE :

The equipment presented in this bulletin is to be installed in accordance with the latest publication standards of NFPA or other similar organisations and also with the provision of government codes or ordinances wherever applicable.

The information provided by us is to the best of our knowledge and belief, and consist of general guidelines only. Site handling and installation control is not in our scope. Hence we give no guarantee for result and take no liability for damages, loss or penalties whatsoever, resulting from our suggestion, information, recommendation or damages due to our product.

Product development is a continuous programme of HD FIRE PROTECT PVT. LTD. and hence the right to modify any specification without prior notice is reserved with the company.



HD FIRE PROTECT PVT. LTD.
Protecting What Matters Most to You

D-6/2, ROAD NO. 34, WAGLE INDUSTRIAL ESTATE, THANE 400 604, INDIA.

• TEL: + (91) 22 2158 2600

• FAX: +(91) 22 2158 2602

• EMAIL: info@hdfire.com

• WEB: www.hdfire.com