



ROTAREX
FIRETEC



CO₂
EQUIPMENT FOR CO₂
FIRE SUPPRESSION SYSTEMS

JUNE 2018

TABLE OF CONTENTS

A COMPLETE COMPONENT SOLUTION	P.004
PRODUCT RANGE OVERVIEW	P.006
TECHNOLOGY OVERVIEW	P.008
- Valve Technology	P.008
- DIMES digital measurement system	P.010
- DIMES connector cables	P.011
SERIES B0480 VALVES FOR CO₂ SYSTEMS	P.012
- B0480 DIMES cylinder/valve assemblies	P.012
- Series B0480 valves	P.013
- DIMES accessories	P.014
ACTUATION DEVICES & ACCESSORIES	P.015
- Manual and pneumatic actuators	P.015
- Electromagnetic actuators	P.015
- Actuator accessories	P.016
- Pilot hoses	P.016
DISCHARGE HOSES, MANIFOLD & NOZZLES	P.017
- Discharge hoses	P.017
- Check valves	P.017
- Single-row manifold	P.018
- Double-row manifold	P.018
- Manifold connector & caps	P.019
- Pressure & flow detector switch	P.019
- Electrical directional valves	P.020
- Pneumatic directional valves	P.020
- Control panels	P.021
- Blocking device	P.021
- Pre-assembled nozzles	P.022
- Self-assembly kit nozzles	P.022
MOUNTING BRACKETS	P.023
- Single row	P.023
- Double row	P.023
- Manifold mounting brackets	P.024
SPECIAL APPLICATIONS	P.025
- B0439 cylinder / valve assemblies	P.025
- B0439 DIMES cylinder / valve assemblies	P.026
- Series B0439 valves for CO ₂	P.027
- Series B0430 valves for CO ₂	P.028

Rotarex Firetec system components are approved and certified compliant with recognized international norms. Certifications relate to individual products, and are clearly indicated on each respective product page.

In addition, all Rotarex manufacturing sites comply with ISO 9001 quality standards.



ALL THE COMPONENTS FOR A COMPLETE CO₂ SYSTEM

Rotarex offers all the components needed to configure a complete system for 60 bar carbon dioxide extinguishing agent.

- **Components entirely compatible and interchangeable**
- **Easier and faster installation - No “bad surprises”**
- **Everything to the same high-specification**
- **Greater confidence in performance at the critical time**
- **Full warranty protection**
- **Simplicity of a single supplier**

Rotarex makes it easy for system engineers and installers to configure fixed suppression systems—choosing only select components—or using the entire system

For maximum ease and certainty of performance, specify Rotarex components to configure the entire system.

A complete component solution		
1	Cylinder with DIMES	Page 12
2	Valve	Page 13
3	Multiple cylinder cable connector	Page 14
4	Manual release device	Page 15
5	Pneumatic release device	Page 15
6	Electromagnetic release device	Page 15
7	Bleed valve	Page 16
8	Pilot hose	Page 16
9	Discharge hose	Page 17
10	Check valve	Page 17
11	Manifold	Page 18
12	Nozzle	Page 22
13	Clamp for Cylinder	Page 23
14	Wall Mounting Rail	Page 23
15	Bracket for manifold	Page 24
16	Clamp for manifold	Page 24



SERIES B0480 VALVES FOR CO₂ SYSTEMS



CYLINDER/VALVE ASSEMBLIES P. 012



CYLINDER VALVES P. 013



DIMES ACCESSORIES P. 014

ACTUATION DEVICES & ACCESSORIES



MANUAL ACTUATORS P. 015



MANUAL/PNEUMATIC ACTUATORS P. 015



PNEUMATIC ACTUATORS P. 015



ELECTROMAGNETIC ACTUATORS P. 015



RESET TOOL P. 015



MONITORING SWITCH P. 016



BLEED VALVE P. 016



PILOT HOSES P. 016

DISCHARGE HOSES, MANIFOLDS & ACCESSORIES



DISCHARGE HOSES P. 017



CHECK VALVES P. 017



MANIFOLDS P. 018



MANIFOLD CAPS AND CONNECTORS P. 019



PRESSURE SWITCH P. 019



ELECTRICAL DIRECTIONAL VALVES P. 020



PNEUMATIC DIRECTIONAL VALVES P. 020



CONTROL PANELS
For pneumatic directional valves P. 021



BLOCKING DEVICE
For pneumatic directional valves P. 021

NOZZLES



PRE-ASSEMBLED NOZZLES P. 022



SELF ASSEMBLY NOZZLES P. 022

MOUNTING BRACKETS



SINGLE-ROW BRACKETS P. 023



DOUBLE-ROW BRACKETS P. 023



MANIFOLD BRACKETS P. 024

SPECIAL APPLICATIONS



B0439 CYLINDER / VALVE ASSEMBLIES P. 025



B0439 DIMES CYLINDER / VALVE ASSEMBLIES P. 026



SERIES B0439 VALVES P. 027



SERIES B0430
For marine applications P. 028

VALVE TECHNOLOGIES

ROTAREX THE VALVE EXPERT

Rotarex is the world leader in high-performance cylinder valves for fixed extinguishing systems as well as Ultra High Purity, Medical, Cryogenic, Automotive and LPG applications. They leverage 90-year expertise, vast R&D infrastructure and global scale to provide the most technically advanced and dependable fire suppression valves in the market. Trust Rotarex valves to perform when it most counts.



SERIES B0480

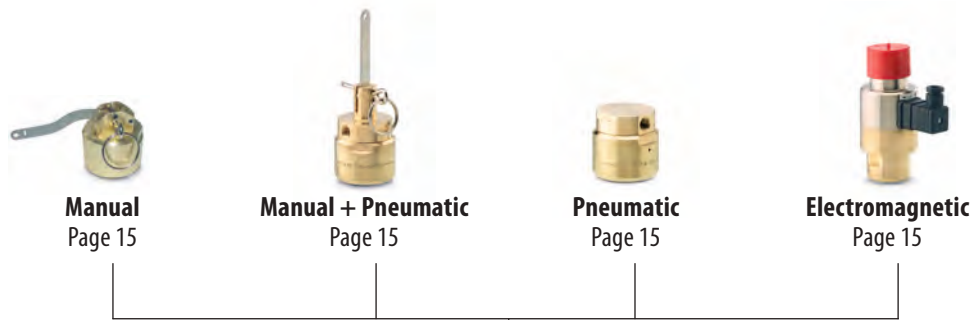

Manual
Page 15

Manual + Pneumatic
Page 15

Pneumatic
Page 15

Electromagnetic
Page 15

Can be used with a range of different actuators

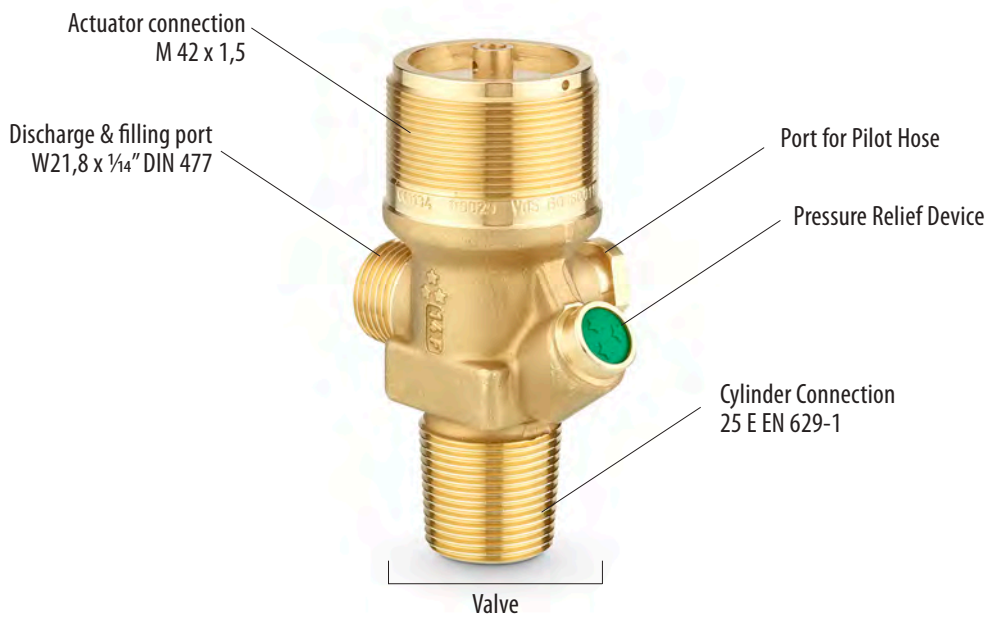

SPECIFICATIONS

Max. working pressure	250 bar	Seat orifice size	12 mm	Temperature range	-20°C to +60°C
Valve body	Brass	Outlet port	W21,8 x 1/4" DIN 477	Burst disc pressure	Available in 190, 225 and 250 bar versions. Other burst pressures on request.

VALVE TECHNOLOGIES (continued)

SERIES B0439 (see page 27)

Can be used as a pilot cylinder valve or for smaller, single cylinder installations where solenoid actuation is required.

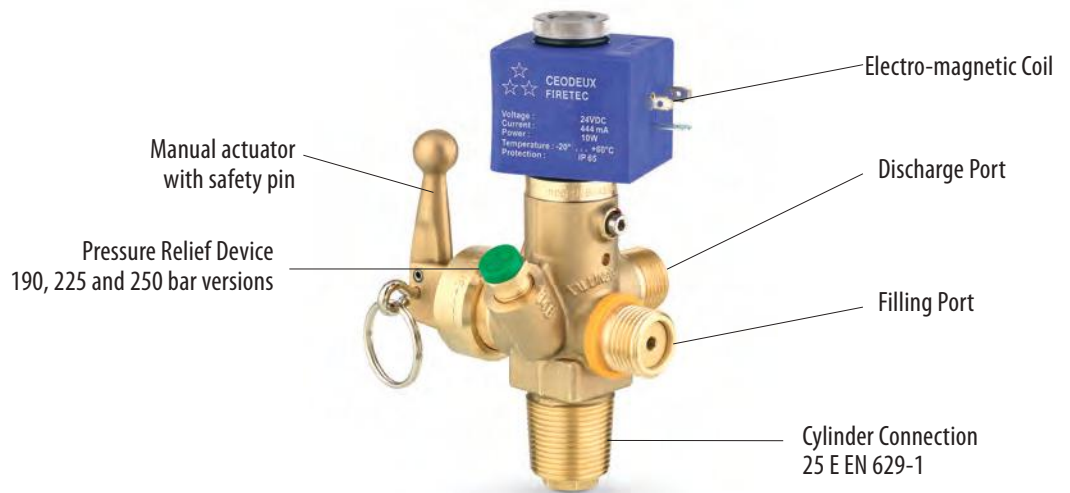

SPECIFICATIONS

Max. Working pressure	250 bar	Temperature range	-20°C to +60°C	Operating voltage	24 VDC
Valve body	Brass	Burst disc pressure	Available in 190, 225 and 250 bar versions. Other burst pressures on request.	Power consumption	10 watt
Seat orifice size	7 mm				

SERIES B0430 (see page 28)

200 bar Valve with manual and pneumatic actuation. Ideal for marine applications

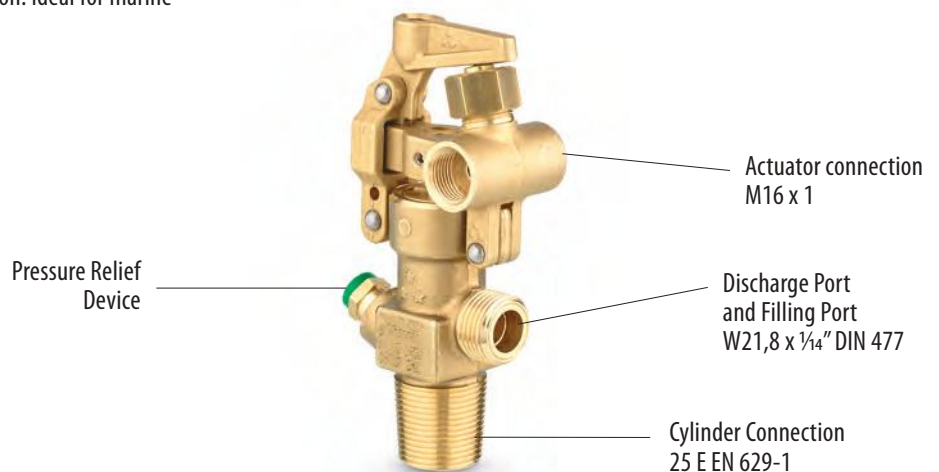

SPECIFICATIONS

Max. Working pressure	250 bar	Seat orifice size	12 mm	Temperature range	-20°C to +60°C
Valve body	Brass	Outlet port	W 21,8 x 1/4"	Max. filling factor	0,75 Kg/l
		Filling port	W 21,8 x 1/4"	Burst disc pressure	190 or 250 bar



Rotarex highly recommends the DIMES system option to enhance productivity and ensure system readiness. DIMES electronically measures the cylinder CO₂ level in real-time – so you have more confidence that the system is armed and ready – and it significantly simplifies annual maintenance.



DIMES valves contain a micro chip that permits calibration of the system to the cylinder of valves. A calibration unit is required

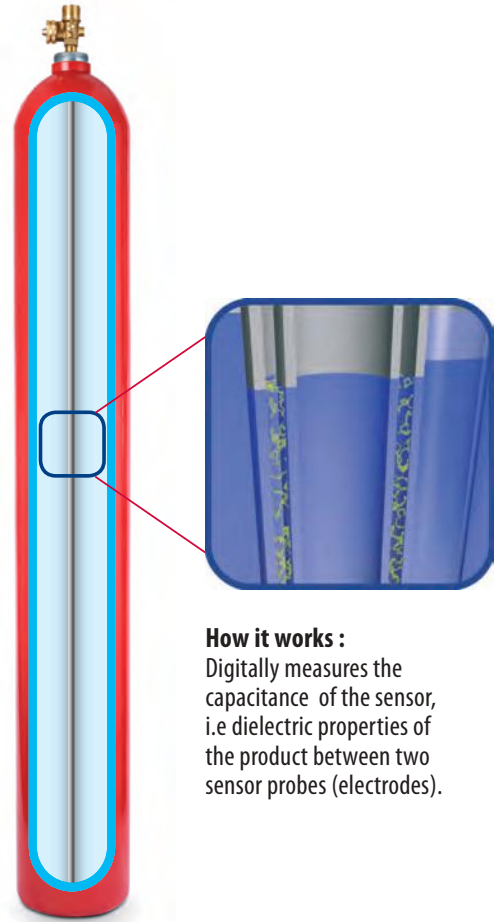

How it works :
Digitally measures the capacitance of the sensor, i.e dielectric properties of the product between two sensor probes (electrodes).

DIMES ACCESSORIES



Control alarm box
Indicates that system is properly armed and sounds audio alarm when the system actuates. Compatible with any control box.

Monitoring switch recommended to:
- monitor system status
- transmit alarm signals
- send an electronic shut-down signal

Calibration unit
Calibrates the valve to the cylinder using a built-in computer chip

Technical characteristics of DIMES - electronic

Supply voltage	6 to 30 VDC	
Temperature range	- 20°C to + 60°C	
Alarm level	80 % (configurable)	
Max. switching power	20 W	
Max. contact rating	0,4 A	
Max. switching voltage	50 V	
Sealed housing	IP 67	
Max. dissipation rating	6 mA	
Max. dissipation power	12 VDC	24 VDC
	72 mW	144 mW



FLEXIBLE CONFIGURATION OPTIONS

DIMES sensor units are available in single and multi-connection versions – connecting either a single cylinder or multiple cylinders in series.

SINGLE CYLINDER



DIMES valve + control box connection cable

MULTIPLE CYLINDERS



2 cylinder cable



3 cylinder cable



4 cylinder cable

DIMES valve + multiple cylinder connector cable + control box connection cable + end connector

DATA TRANSMISSION INTERFACE:

Data can be sent to a special control box or computer for monitoring via the data interface cable

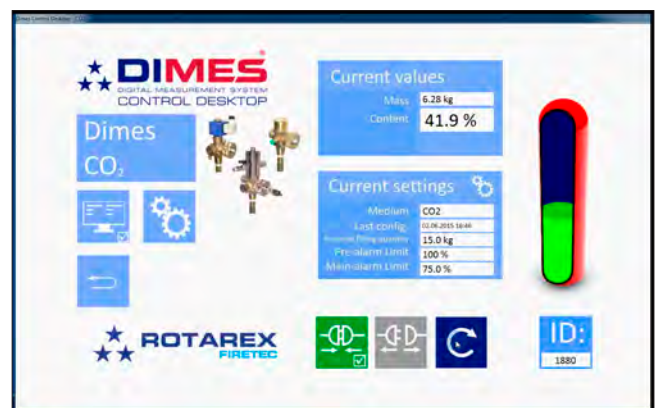

B0480 DIMES CYLINDER/VALVE ASSEMBLIES

A complete cylinder/valve assembly. Includes:

- π marked seamless steel cylinder in choice of sizes
- B0480 cylinder valve with DIMES
- Protection cap

KEY FEATURES

- Improves productivity: cylinder/valves arrive pre-assembled
- Compliant with TPED directive
- Choice of filled or unfilled cylinders

π

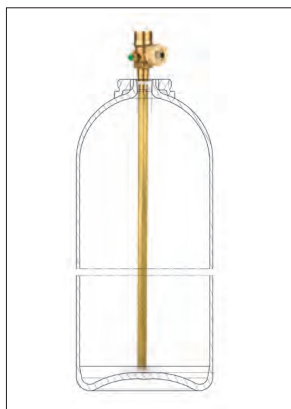

- Specific electrodes adapted to corresponding cylinder length.
- Custom length available on request



	5 Kg.	10 Kg.	20 Kg.	30 Kg.	50 Kg.
Product code unfilled	B04805002	B04805003	B04805004	B04805005	B4805006
Product code filled	B04805502	B04805503	B04805504	B04805505	B4805506
Max. working pressure	250 bar	250 bar	250 bar	250 bar	250 bar
Total length	725 mm	1220 mm	1186 mm	1653 mm	1671 mm
Diameter	Ø140 mm	Ø140 mm	Ø204 mm	Ø204 mm	Ø267 mm
Guard material	Plastic	Plastic	Plastic	Steel	Steel

SERIES B0480 VALVES FOR CO2

Solenoid-actuated cylinder valves for fire suppression systems.



On request

KEY FEATURES

- Available in total discharge version
- Requires actuator device (see page 15)
- Special connections available on request
- ATEX-approved versions available on demand
ATEX versions may not be used with electromagnetic actuator



Burst disc pressure
190 bar



Burst disc pressure
225 bar



Burst disc pressure
250 bar

SPECIFICATIONS

Product code	B04800111	B04800113	B04800110
Discharge type	Total	Total	Total
Max. working pressure	190 bar	225 bar	250 bar
Orifice size	Ø12 mm	Ø12 mm	Ø12 mm
Inlet connection	25E EN-629-1	25E EN-629-1	25E EN-629-1
Outlet connection	W21,8x1/14" DIN 477	W21,8x1/14" DIN 477	W21,8x1/14" DIN 477
Actuator connection	M42 x 1,5	M42 x 1,5	M42 x 1,5
Dip tube connection	M10 x 0,75	M10 x 0,75	M10 x 0,75
Burst disc pressure	190 bar	225 bar	250 bar
Valve body	Brass	Brass	Brass

1 Compliant with the Construction Products Regulation (CPR) V3 Oct. 2014

DIMES CALIBRATION UNIT

Digital display and calibration device for DIMES digital measurement system.

See p.10 for details



Product code | B07850200

KEY FEATURES

- Calibrates valve to cylinder and saves data via a built-in microchip
- Digital display can also be used to monitor system

DIMES CONNECTOR CABLES

To connect the DIMES valve to a DIMES Alarm box.



	SINGLE CYLINDER	TWO CYLINDERS	THREE CYLINDERS
Product code	029900088	029900079	029900080
Pins	8-pin	8-pin	8-pin
Cable length	2000 mm	500 mm between cylinder	500 mm between cylinder



	FOUR CYLINDERS	EIGHT CYLINDERS	END CONNECTOR	CONTROL BOX CABLE
Product code	029900081	029900082	029900083	029900089
Pins	8-pin	8-pin	4-pin	4-pin
Cable length	500 mm between cylinder	500 mm between cylinder	-	2000 mm

RELEASE DEVICES

Devices to actuate the release of extinguishing agent.

For use with Series B0481, B0482 and B0480 Valves.



	Manual	Manual / Pneumatic		Pneumatic	
Product code	B04420100	B04420065	B04420116	B04420066	B04420076
Technology	single piston	single piston	double piston	single piston	double piston
Max. pressure	300 bar	300 bar	300 bar	300 bar	300 bar
Valve connection	M 42 x 1,5	M 42 x 1,5	M 42 x 1,5	M 42 x 1,5	M 42 x 1,5
Pneumatic connection	-	G1/8"	G1/8"	G1/8"	G1/8"
Actuation force / pressure	< 150 N	< 150 N / 20 bar	< 150 N / 10 bar	20 bar	10 bar
Body material	Brass	Brass	Brass	Brass	Brass
Height	54	136,5	156,5	50	71
Diameter	Ø50	Ø50	Ø50	Ø50	Ø50

ELECTROMAGNETIC RELEASE DEVICE

Device to electrically actuate the release of extinguishing agent.

For use with Series B0481, B0482 and B0480 Valves.



KEY FEATURES

- Most commonly used as a master valve to actuate the system electronically, such as with connection to a smoke or heat detection device
- Electronically actuates the release of extinguishing agent

WITH BLOCKING DEVICE.

To temporarily unarm the system during maintenance



B04425131



B04425132



B04425109



B04425129



	With diode	Without diode	With diode	Without diode
Valve connection	M42 x 1,5	M42 x 1,5	M42 x 1,5	M42 x 1,5
Nominal voltage	24 VDC	24 VDC	24 VDC	24 VDC
Electrical connection	-	-	PG 9	PG 9
Nominal current	0,5 A	0,5 A	0,5 A	0,5 A
Protection Class	IP65	IP65	IP65	IP65
Height	135 mm	135 mm	135 mm	135 mm
Diameter	Ø 65 mm	Ø 65 mm	Ø 80 mm	Ø 80 mm

1 Compliant with the Construction Products Regulation (CPR) V3 Oct. 2014

RESET TOOL FOR ELECTROMAGNETIC ACTUATOR

Used to reset the electromagnetic actuator piston when putting the system back in active service after system discharge.



Product code	029210064
Connection	M 42 x 1,5
Material	Brass



Safety cap included



Screws into the base of B04425XXX electromagnetic release device

MONITORING SWITCH

Monitors that the actuator is properly in place to actuate the system.

Connects to the alarm box.

Mandatory according to NFPA 2001 Standard on Clean Agent Extinguishing systems – 2015 edition – (applicable for CO₂ system).

KEY FEATURES

- Compact design: remains in the cylinder diameter
- Easy installation: simply clamps around the valve base
- Retrofit of existing installations possible



Product code	029905200
Description	Mounted on B0480 valve

BLEED VALVE

To vent overpressure and prevent false system discharge in the event of a small pressure leak from the cylinders into the pneumatic actuators.

VdS
tested

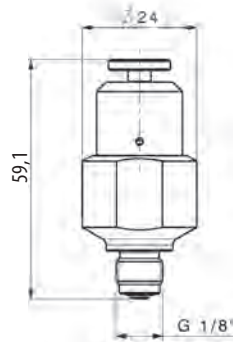

Product code	029730040
Pneumatic connection	G 1/8"
Closing pressure	between 0,7 to 1,5 bar
Flow at p=0.6 bar	6 liters/min

PILOT HOSES

Hose to connect multiple cylinders in a series.

Connects a master valve or a pneumatic actuator with another pneumatic actuator.

VdS CE¹



Adapter must be ordered separately.
2 per hose.

- Both ends have a straight fitting
- 400 bar working pressure
- With O-rings

STRAIGHT PILOT HOSE FOR B0480

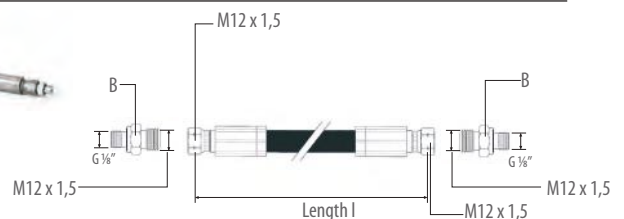

	Product code	Length l	Connection	Bending radius
A1	B06920211	400 mm	2 x M12 x 1,5	75 mm
A2	B06920212	700 mm	2 x M12 x 1,5	75 mm
A3	B06920213	500 mm	2 x M12 x 1,5	75 mm
Adapter B	029510006		M12 x 1,5 / G 3/8	

SPECIFICATIONS

Working pressure	400 bar	Temperature Range	-40°C to 100°C	Interior diameter	1/8"
Burst pressure	1600 bar	Material	Synthetic rubber oil resistant	Norm	EN 857 2 SC
Torque	20-25 Nm				

¹ Compliant with the Construction Products Regulation (CPR) V3 Oct. 2014

DISCHARGE HOSES

Hose to connect the cylinder valve to the manifold in fixed fire suppression systems.



DN 12 90° ELBOW



Product code	B06920226
Working pressure	380 bar
Burst pressure	1520 bar
Temperature range	-40°C to 100°C
Torque	38-42 Nm
Material	Synthetic rubber oil resistant
Norm	EN 853 2 SN
Valve connection (inlet)	W 21,8 x 1/4" DIN 477
To manifold connection (outlet)	G 3/4"
Bending radius	130 mm
Length	450 mm

CHECK VALVE

Prevents backflow into the cylinder.

Required for each hose attachment to the discharge manifold.



Product code	B04600008
Max working pressure	360 bar
Gases	IG01, IG55, IG100, IG541, CO ₂
Material	Brass
Hose connection	G 3/4"
Manifold connection	R1"

¹ Compliant with the Construction Products Regulation (CPR) V3 Oct. 2014

MANIFOLD FOR CO₂ – 1 ROW

Manifolds to connect from 2 to 5 cylinders.
Single row configuration.



Max working pressure: 100 bar

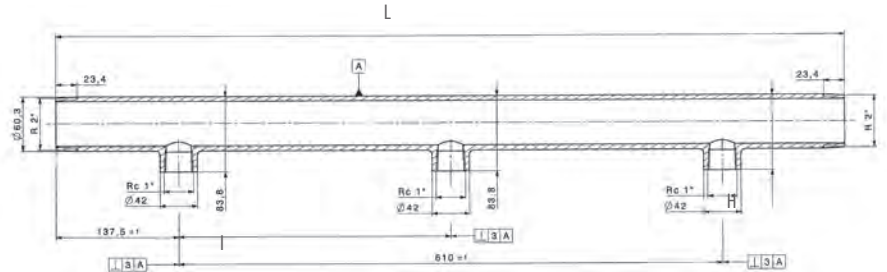

Inlets: Rc 1"	Product code	Length L	Length I	Height H
2 cylinders	B05800013	580 mm	305 mm	83,8 mm
3 cylinders	B05800014	885 mm	305 mm	83,8 mm
5 cylinders	B05800015	1495 mm	305 mm	83,8 mm

SPECIFICATIONS

Working pressure	Max 100 bar	Gases	IG01, IG55, IG100, IG541, CO ₂	Connection	Rc1"
Test pressure	150 bar	Surface	Hot dip galvanized steel	Outlet Connection	R2"

MANIFOLD FOR CO₂ – 2 ROWS

Manifolds to connect from 4 to 10 cylinders.
Double row configuration.



Max working pressure: 100 bar

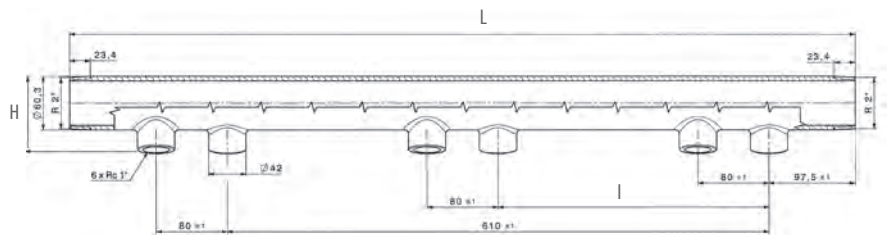

Inlets: Rc 1"	Product code	Length L	Length I	Height H
4 cylinders	B05800016	580 mm	305 mm	83,8 mm
6 cylinders	B05800017	885 mm	305 mm	83,8 mm
10 cylinders	B05800018	1495 mm	305 mm	83,8 mm

SPECIFICATIONS

Working pressure	Max 100 bar	Gases	IG01, IG55, IG100, IG541, CO ₂	Connection	Rc1"
Test pressure	150 bar	Surface	Hot dip galvanized steel	Outlet Connection	R2"

² According to the Pressure Equipment Directive (97/23/EC)

MANIFOLD CONNECTORS AND CAPS

- Fittings to connect or seal Firetec manifolds
- Respects standards ISO 49 and EN 10242
- Red dot confirms testing up to 300 bar

MANIFOLDS CONNECTOR

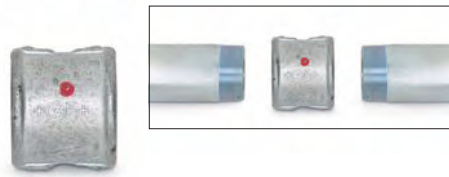

END CAP

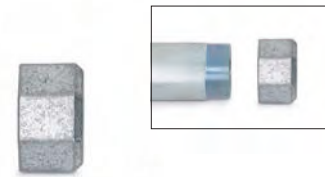

Product code	026300500	023400100
Working pressure	100 bar	100 bar
Test pressure	300 bar	300 bar
Surface	Hot dip galvanized steel	Hot dip galvanized steel
Connection	G2"	G2"

PRESSURE & FLOW DETECTOR SWITCH

Used to send a signal when the system is discharging.

Pressure Activated.



CE²

KEY FEATURES

- Sends a signal to a control panel or alarm box at the earliest phase of discharge
- Actuated at 2 bar pressure
- Flexible Voltage/Amp power source

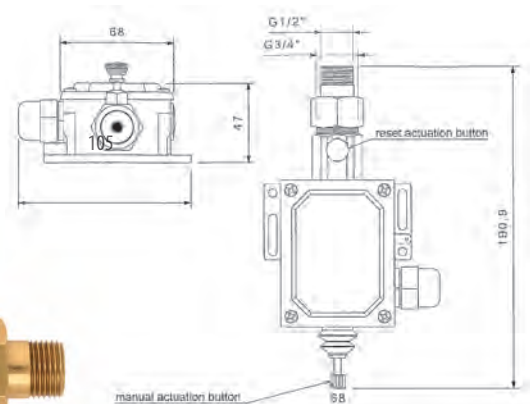

Product code	028250050
Opening Pressure	2 bar
Design Pressure	200 bar
Test pressure	300 bar
Connection	G 1/2"
Power source	400 VAC / 3A or 24 VDC / 10 A
Protection	IP65

2 According to the Pressure Equipment Directive (97/23/EC)

ELECTRIC DIRECTIONAL VALVE

Valve and actuator assembly to isolate separate protection zones from the same cylinder rack.

Includes valve + bracket + motor.

Permits discharge only in the zone with the fire.



KEY FEATURES

- Available in Carbon Steel or Stainless Steel versions
- Choice of 5 diameters: 1"/1,5"/2"/2,5"/3"
- 2-way ball valve
- User-defined installation position and flow-direction
- Output of 2 limit switches
- Electronic over-torque protection
- LED status indication
- Plugs with ISO440 and C192
- IP 67



Can only operate without pressure load



Product code - Carbon steel	B05511000	B05511100	B05511200	B05511300	B05511400	B05511500
Product code - Stainless Steel	B05511001	B05511101	B05511201	B05511301	B05511401	B05511501
Size	1"	1,5"	2"	2,5"	3"	4" (flange)
DN	25	40	50	65	80	100
Unit nominal pressure (@20°C)	300 bar	300 bar	300 bar	300 bar	300 bar	300 bar
Voltage	24 V DC	24 V DC	24 V DC	24 V DC	24 V DC	24 V DC
Consumption at max. torque	800 mA/19W	1200 mA/28W	1200 mA/28W	1210 mA/29W	1210 mA/29W	1780 mA/43W
Operating time 90°	10 sec	10 sec	10 sec	14 sec	14 sec	34 sec
Duty rate	75%	75%	75%	75%	75%	75%
Temperature range carbon steel	-20° C to 100° C	-20° C to 100° C	-20° C to 100° C	-20° C to 100° C	-20° C to 100° C	-20° C to 100° C
Temperature range stainless steel	-30° C to 100° C	-30° C to 100° C	-30° C to 100° C	-30° C to 100° C	-30° C to 100° C	-30° C to 100° C
Weight	8 kg	11,9 kg	13,1 kg	38,9 kg	48,9 kg	75,2 kg
Seal material	POM (greased), NBR	POM (greased), NBR	POM (greased), NBR	POM (greased), NBR	POM (greased), NBR	POM (greased), NBR
Length	207 mm	196mm	200mm	225 mm	204 mm	258 mm
Height	292 mm	323 mm	329 mm	440,5 mm	456 mm	555 mm
Width	110 mm	116 mm	122 mm	187 mm	241 mm	200 mm
Pipe Connector length	168 mm	167 mm	175 mm	212 mm	239 mm	200 mm

2 According to the Pressure Equipment Directive (97/23/EC)

PNEUMATIC DIRECTIONAL VALVE

Pneumatic or manual actuation.

Valve and actuator assembly to isolate separate protection zones from the same cylinder rack.

Includes valve + bracket + pneumatic actuator + manual wrench.

Permits discharge only in the zone with the fire.



KEY FEATURES

- Choice of 5 diameters: 1"/1,5"/2"/2,5"/3"
- 2-way ball valve
- User-defined installation position and flow-direction
- Stainless steel ball valve with carbon steel housing
- Status indication
- IP 67



Product code - Carbon steel	B05511050	B05511150	B05511250	B05511350	B05511450
Size	1"	1,5"	2"	2,5"	3"
DN	25	40	50	65	80
Unit nominal pressure (@20°C)	140 bar	140 bar	140 bar	140 bar	140 bar
Actuation pressure	8 bar +/- 2 bar	8 bar +/- 2 bar	8 bar +/- 2 bar	8 bar +/- 2 bar	8 bar +/- 2 bar
Actuation medium	N ₂	N ₂	N ₂	N ₂	N ₂
Pilot pressure	6-10 bar	6-10 bar	6-10 bar	6-10 bar	6-10 bar
Temperature range stainless steel	-20° C to 50° C	-20° C to 50° C	-20° C to 50° C	-20° C to 50° C	-20° C to 50° C
Weight	7 kg	12 kg	14 kg	70 kg	88 kg
Seal material	POM (greased), NBR	POM (greased), NBR	POM (greased), NBR	POM (greased), NBR	POM (greased), NBR
Length	209 mm	221mm	221mm	298 mm	298 mm
Height	371,5 mm	433 mm	447 mm	583,5 mm	600 mm
Width	110,5 mm	120 mm	120 mm	137 mm	137 mm
Pipe Connector length	113 mm	130 mm	140 mm	220 mm	226 mm

1 Compliant with the Construction Products Regulation (CPR) V3 Oct. 2014

2 According to the Pressure Equipment Directive (97/23/EC)

CONTROL PANEL FOR PNEUMATIC DIRECTIONAL VALVES

Wall-mounted switching panel to control directional valve position. Sends a signal to open the directional valve in the zone with a fire.

KEY FEATURES

- Available in multiple versions from 2 to 15 zone protection
- Hose B06920212 included

Protection Zones	Product code	Dimensions (LxH)
2	B05520200	470 x 450
3	B05520300	470 x 450
4	B05520400	470 x 450
5	B05520500	470 x 450
6	B05520600	470 x 450
7	B05520700	700 x 450
8	B05520800	700 x 450
9	B05520900	700 x 450
10	B05521000	700 x 450
11	B05521100	700 x 450
12	B05521200	940 x 450
13	B05521300	940 x 450
14	B05521400	940 x 450
15	B05521500	940 x 450

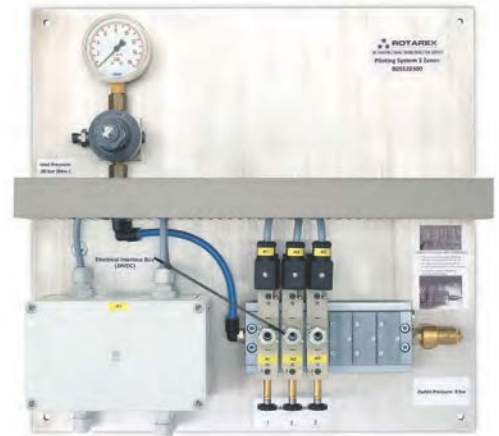

SPECIFICATIONS

Connection thread	G 1/4"	Operating temperature	-20°C to 50°C	Nominal voltage	24 VDC
Maximum inlet pressure	60 bar	Inlet connection for hi-flex hose	1/4"	Operating medium	Nitrogen
Outlet operating pressure	8 bar				

BLOCKING DEVICE FOR PNEUMATIC DIRECTIONAL VALVES

To avoid unintentional operation of directional valves during maintenance.

Mandatory for VdS installations.

VdS

KEY FEATURES

- Easily installs between control panel and directional valve
- Can be locked with a padlock to prevent unintentional
- Two easy-to-read switch positions (open or closed)
- One for each directional valve



With included padlock

Product code	B05512000
Max operating pressure	10 bar
Material	24HA
Outlet thread	G 1/2"
Voltage	G 1/4" / DN6 24 VDC

DISCHARGE NOZZLES | PRE-ASSEMBLED

Pre-bored and fully assembled discharge nozzles for CO₂ systems.

For faster and easier installation.



KEY FEATURES

- Max. working pressure 300 bar
- Material: brass
- Special orifice diameters available on request



Size of thread	Product code	Orifice Diameter	Product code	Orifice Diameter
R1/2"	B04611100	3 mm	B04611108	3,5 mm
	B04611101	4 mm	B04611109	4,5 mm
	B04611102	5 mm	B04611110	5,5 mm
	B04611103	6 mm	B04611111	6,5 mm
	B04611104	7 mm	B04611112	7,5 mm
	B04611105	8 mm	B04611113	8,5 mm
R3/4"	B04611106	9 mm	B04611114	9,5 mm
	B04611200	7 mm	B04611208	7,5 mm
	B04611201	8 mm	B04611209	8,5 mm
	B04611202	9 mm	B04611210	9,5 mm
	B04611203	10 mm	B04611211	10,5 mm
	B04611204	11 mm	B04611212	11,5 mm
R1"	B04611205	12 mm	B04611213	12,5 mm
	B04611206	13 mm	B04611214	13,5 mm
	B04611300	10 mm	B04611309	10,5 mm
	B04611301	11 mm	B04611310	11,5 mm
	B04611302	12 mm	B04611311	12,5 mm
	B04611303	13 mm	B04611312	13,5 mm
R1 1/2"	B04611304	14 mm	B04611313	14,5 mm
	B04611305	15 mm	B04611314	15,5 mm
	B04611306	16 mm	B04611315	16,5 mm
	B04611307	17 mm	B04611316	17,5 mm
	B04611400	15 mm	B04611412	15,5 mm
	B04611401	16 mm	B04611413	16,5 mm
	B04611402	17 mm	B04611414	17,5 mm
	B04611403	18 mm	B04611415	18,5 mm
	B04611404	19 mm	B04611416	19,5 mm
	B04611405	20 mm	B04611417	20,5 mm
	B04611406	21 mm	B04611418	21,5 mm
	B04611407	22 mm	B04611419	22,5 mm
	B04611408	23 mm	B04611420	23,5 mm
	B04611409	24 mm	B04611421	24,5 mm
	B04611410	25 mm	B04611422	25,5 mm

DISCHARGE NOZZLES | SELF-ASSEMBLY KIT

Discharge nozzles where you drill the orifice to your required orifice diameter and assemble yourself.

Easier to stock. A more economical alternative.

KEY FEATURES

- Max. working pressure 300 bar
- Material: brass



Size of thread	Product code	Orifice Diameter	Maximum bore diameter
R1/2"	B04610100	3	up to 9,5 mm
R3/4"	B04610200	7	up to 13,5 mm
R1"	B04610300	10	up to 17,5 mm
R1 1/2"	B04610400	15	up to 25,5 mm

1 Compliant with the Construction Products Regulation (CPR) V3 Oct. 2014

CYLINDER MOUNTING BRACKETS - SINGLE ROW

Wall mounting rail, cylinder clamps and end caps parts to mount 20kg -30kg - 50kg cylinders to the wall.

KEY FEATURES

- Galvanized steel components for solid support and a long service lifetime
- Wall mounting rail available in multiple lengths to accommodate between 1 – 5 cylinders
- Multiple brackets can be used for more than 5 cylinders



1

WALL MOUNTING RAIL

Input	Length L	Product code
1 cylinder	400 mm	024900311
2 cylinders	645 mm	024900312
3 cylinders	940 mm	024900313
4 cylinders	1240 mm	024900314
5 cylinders	1535 mm	024900315

2

CLAMP FOR CYLINDER

Fits cylinder size	Product code
20kg - 30kg	024900424
50kg	024900321

3

END CAP FOR MOUNTING RAIL AND BRACKET

Product code
024900322

CYLINDER MOUNTING BRACKETS - DOUBLE ROW

Brackets to secure a double-row of 20kg -30kg or 50kg cylinders.

KEY FEATURES

- Available in two sizes for 2 or 3 cylinders
- Bracket length: 645 mm for 2 cylinders or 940 mm for 3 cylinders



Order 1 bolt & nuts kit for 2 cylinders configurations and 2 kits for 3 cylinders.

1

WALL MOUNTING RAIL

2

RAIL BRACKET

3

MIDDLE BRACKET

4

OUTER BRACKET

5

BOLTS & NUTS KIT

Product code		Product code		Product code		Product code		Product code	
2 cylinders	024900312	2 cylinders	024900323	2 cylinders	024900324	2 cylinders	024900325	Mounting kit	024900329
3 cylinders	024900313	3 cylinders	024900326	3 cylinders	024900327	3 cylinders	024900328		

MANIFOLD MOUNTING BRACKETS

System of brackets, clamps and end caps to mount manifolds to the wall.

KEY FEATURES

- Galvanized steel components for solid support and a long service lifetime
- Manifold clamps available in 2" diameters.

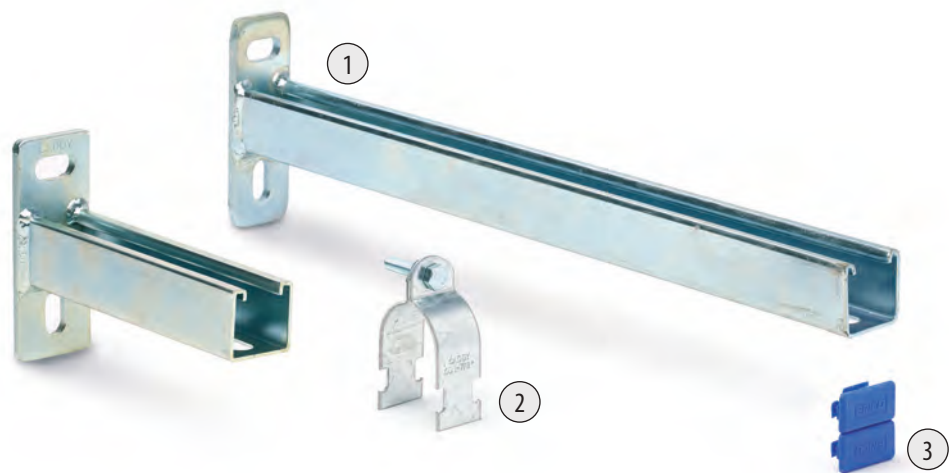

1

BRACKET FOR MANIFOLD

	Length A	Product code
Single row	205 mm	B05805000
Double row	505 mm	B05805001

2

CLAMP FOR MANIFOLD

Diameter	Product code
2"	B05805004

3

END CAP FOR MOUNTING RAIL AND BRACKET

Product code
024900322

B0439 CYLINDER/VALVE ASSEMBLIES

A complete cylinder/valve assembly.

Often used as a pilot cylinder for liquid-based systems or for smaller installations using a single cylinder.

Includes:

- π marked steel cylinder in choice of sizes
- B0439 cylinder valve
- Protection cap

KEY FEATURES

- Improves productivity: cylinder/valves arrive pre-assembled and ready-to-fill
- Compliant with TPED directive
- Choice of filled or unfilled cylinders
- Equipped with the B04390030 valve (see p.27)

π



	2 Kg.	5 Kg.	10 Kg.	20 Kg.	30 Kg.
Product code unfilled	B04394001	B04394000	B04394002	B04394007	B04394008
Product code filled	B04394501	B04394500	B04394502	On request	On request
Max. working pressure	250 bar	250 bar	250 bar	250bar	250 bar
Operating temperature	-20°C to 60°C	-20°C to 60°C	-20°C to 60°C	-20°C to 60°C	-20°C to 60°C
Length w/ cap	626 mm	725 mm	732 mm	1189mm	1682mm
Diameter	Ø108 mm	Ø140 mm	Ø204 mm	Ø204mm	Ø204mm
Discharge type	Total	Total	Total	Total	Total
Orifice size	Ø7 mm	Ø7 mm	Ø7 mm	Ø7 mm	Ø7 mm
Inlet connection	25E EN-629-1	25E EN-629-1	25E EN-629-1	25E EN-629-1	25E EN-629-1
Outlet connection	W21,8x1/14" DIN 477	W21,8x1/14" DIN 477	W21,8x1/14" DIN 477	W21,8x1/14" DIN 477	W21,8x1/14" DIN 477
Operating voltage	24 V DC	24 V DC	24 V DC	24 V DC	24 V DC
Power consumption	10 Watt	10 Watt	10 Watt	10 Watt	10 Watt
Burst disc pressure	250 bar	250 bar	250 bar	250 bar	250 bar
Valve body	Brass	Brass	Brass	Brass	Brass

B0439 DIMES CYLINDER/VALVE ASSEMBLIES

A complete cylinder/valve assembly.

Often used as a pilot cylinder for liquid-based systems or for smaller installations using a single cylinder.

Includes:

- π marked seamless steel cylinder in choice of sizes
- B0439 cylinder valve with DIMES
- Protection cap

KEY FEATURES

- Improves productivity: cylinder/valves arrive pre-assembled
- DIMES system eliminates the need to weigh cylinders (see page 10)
- Compliant with TPED directive
- Choice of filled or unfilled cylinders

π



	5 Kg.	10 Kg.	30 Kg.	50 Kg.
Product code unfilled	B04395004	B04395000	B04395001	B04395002
Product code filled	B04395504	B04395500	B04395501	B04395502
Max. working pressure	250 bar	250 bar	250 bar	250 bar
Operating temperature	-20°C to 60°C	-20°C to 60°C	-20°C to 60°C	-20°C to 60°C
Length w/ cap	725 mm	732 mm	1642 mm	1672 mm
Diameter	Ø140 mm	Ø204 mm	Ø204 mm	Ø204 mm
Guard material	plastic	plastic	steel	steel
Discharge type	Total	Total	Total	Total
Orifice size	Ø7 mm	Ø7 mm	Ø7 mm	Ø7 mm
Inlet connection	25E EN-629-1	25E EN-629-1	25E EN-629-1	25E EN-629-1
Outlet connection	W21,8x1/14" DIN 477	W21,8x1/14" DIN 477	W21,8x1/14" DIN 477	W21,8x1/14" DIN 477
Dip tube connection	M 10 x 0,75	M 10 x 0,75	M 10 x 0,75	M 10 x 0,75
Operating voltage	24 V DC	24 V DC	24 V DC	24 V DC
Power consumption	10 Watt	10 Watt	10 Watt	10 Watt
Burst disc pressure	250 bar	250 bar	250 bar	250 bar
Valve body	Brass	Brass	Brass	Brass

SERIES B0439 VALVES FOR CO₂

Cylinder valves with integrated solenoid actuation for 60 bar CO₂ fire suppression systems.

Often used for pilot cylinders for liquid-based systems or for smaller installations using a single cylinder.

KEY FEATURES

- Available in total discharge or intermittent discharge versions
- ATEX version available
- Special connections available on request
- Other burst-disc pressures available on request

π CE¹



Total Discharge

Intermittent

Total Discharge ATEX approved

	Total Discharge		Intermittent		Total Discharge ATEX	
Product code	B04390030	B04390031	B04390503	B04390505	B04390046	B04390051
Discharge type	Total	Total	Intermittent	Intermittent	Total	Total
Max. working pressure	250 bar	190 bar	250 bar	190 bar	190 bar	250 bar
Orifice size	Ø7 mm	Ø7 mm	Ø7 mm	Ø7 mm	Ø7 mm	Ø7 mm
Inlet connection	25E EN-629-1	25E EN-629-1	25E EN-629-1	25E EN-629-1	25E EN-629-1	25E EN-629-1
Outlet connection	W21,8x1/14" DIN 477	W21,8x1/14" DIN 477	W21,8x1/14" DIN 477	W21,8x1/14" DIN 477	W21,8x1/14" DIN 477	W21,8x1/14" DIN 477
Dip tube connection	M 10 x 0,75	M 10 x 0,75	M 10 x 0,75	M 10 x 0,75	M 10 x 0,75	M 10 x 0,75
Operating voltage	24 V DC	24 V DC	24 V DC	24 V DC	24 V DC	24 V DC
Power consumption	10 Watt	10 Watt	10 Watt	10 Watt	11,4 Watt	11,4 Watt
Burst disc pressure	250 bar	190 bar	250 bar	190 bar	190 bar	250 bar
Valve body	Brass	Brass	Brass	Brass	Brass	Brass

¹ Compliant with the Construction Products Regulation (CPR) V3 Oct. 2014

SERIES B0430 VALVES FOR CO₂

Manual or Pneumatically-actuated valve for CO₂ fire suppression systems.

Ideal for marine applications.

KEY FEATURES

- Special connections available on request
- Other burst-disc pressures available on request

Π



Lever available, 029740001



B0430 valve



Manual actuator lever

Product code	B04300000	029740001
Discharge type	Total	-
Max. working pressure	250 bar	-
Orifice size	Ø12 mm	-
Inlet connection	25E EN-629-1	-
Outlet connection	W21,8x1/14" DIN 477	-
Actuator connection	G 3/8"	M10
Dip tube connection	M16 x 1	-
Burst disc pressure	250 bar	-
Valve Body	Brass	Polyamide / brass

A FULL LINE OF GAS CONTROL SOLUTIONS



COMPLETE SOLUTIONS FROM SOURCE TO PROCESS.

ROTAREX is helping engineers worldwide to get better gas results: from ultra high purity production and medical care facilities to industrial and LPG applications, as well as alternative energy vehicles, fire suppression, diving, aerospace, cryogenics, laboratory, petro-chemical and welding. ROTAREX applies over 90 years of know-how and experience to custom design, develop and manufacture the high performance valves, regulators and fittings to suit your needs, all in one hand. Discover the difference ROTAREX can make in your world.

CYLINDER VALVES

EQUIPMENT

FIRETEC

AUTOMOTIVE

LPG/SRG

MEDITEC



ULTRA HIGH PURITY VALVES



MEDICAL VALVES & EQUIPMENT



INDUSTRIAL CYLINDER VALVES



REFRIGERANT CYLINDER VALVES



PRESSURE REGULATORS



SUPPLY & SWITCH OVER BOARDS



LINE VALVES



FITTINGS & ADAPTORS



**FIXED INSTALLATION
FIRE SYSTEMS**



**OBJECT FIRE SUPPRESSION
SYSTEMS**



**AUTOMOTIVE VALVES
& REGULATORS**



WATER CARBONATION



**LPG TANK VALVES
& REGULATORS**



**LPG CYLINDER VALVES
& REGULATORS**



**DIGITAL MEASUREMENT
SYSTEMS**



PLASTIC INJECTION MouldING

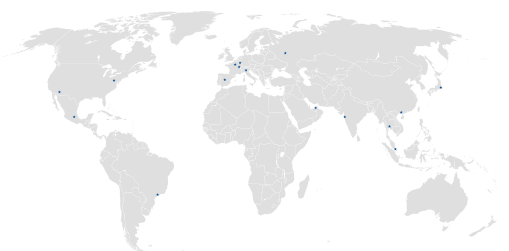

WORLDWIDE HEADQUARTERS

ROTAREX S.A.

24, rue de Diekirch,
L-7440 Lintgen
Luxembourg
Tel.: +352 32 78 32-1
Fax: +352 32 78 32-854
E-mail: firetec@rotarex.com



REGIONAL / COUNTRY HEADQUARTERS

NORTH AMERICA

USA

Rotarex North America
Hackettstown
E-mail: northamerica@rotarex.com

SOUTH AMERICA

BRASIL

Rotarex Brazil Ltda
São Paulo
E-mail: brasil@rotarex.com

CENTRAL AMERICA

MEXICO

Rotarex Mexico
Mexico City
E-mail: mexico@rotarex.com

EUROPE

EUROPEAN HEADQUARTERS

Rotarex S.A. Luxembourg
24, rue de Diekirch,
L-7440 Lintgen, Luxembourg
Tel.: +352 32 78 32-1
E-mail: firetec@rotarex.com

ITALY

Rotarex Italia S.r.l.
Ciliverghe di Mazzano
E-mail: italia@rotarex.com

SPAIN

Rotarex Spain
Madrid
E-mail: spain@rotarex.com

FRANCE

Rotarex France
Paris
E-mail: rotarexparis@rotarex.com

RUSSIA

Rotarex Rus
Moscow
E-mail: russia@rotarex.com

POLAND

Rotarex Polska
Brzeg
E-mail: polska@rotarex.com

ASIA - PACIFIC

SINGAPORE

Rotarex Fareast Pte Ltd
Singapore
E-mail: fareast@rotarex.com

CHINA

Rotarex Star
Shanghai
E-mail: china@rotarex.com

JAPAN

Rotarex Japan Ltd
Tokyo
E-mail: japan@rotarex.com

INDIA

Rotarex ENGG. PVT. LTD.
Mumbai
E-mail: india@rotarex.com

THAILAND

Rotarex (Thailand) Co Ltd.
Pakkret
E-mail: thailand@rotarex.com

TAIWAN

Rotarex Taiwan
Taipei
E-mail: taiwan@rotarex.com

MIDDLE EAST / AFRICA

MIDDLE EAST

Rotarex Middle East
Dubai
E-mail: middle-east@rotarex.com



For more contact details go to
www.rotarexfiretec.com/locations